

SHARP

Be Original.

BP-20C25
BP-20C20
BP-10C20

Digital Full Colour Multifunctional System

Free to Fit
Goes wherever you want



Where will you put it?

Get the job done with a smartly designed full-colour A3 MFP from Sharp. It has a clean and compact 560 mm-wide profile, so you can place it on a desk, on a counter—almost anywhere. The simple interface of this MFP makes it easy and intuitive to operate. And its ability to handle a wide range of essential business functions is sure to enhance your workflow. As a standalone machine or as part of an office network of MFPs, it's built to fit in perfectly in any workplace.



ARReader



AR (augmented reality) app

Read one of the QR Codes® on the right to download the free ARReader® app, and use the app to read the AR marker printed on this page. The MFP will appear on your device screen as a virtual 3D image*.

*On-screen image not shown to scale.



iOS



Android™



4-in-1 Functionality

Four functions—copier, printer, scanner, and fax*—are packed into one compact unit.

*Not available on BP-10C20. BP-20C25/20C20 requires optional BP-FX10.



Compact Size

Measuring just 560 × 560 × 560 mm*, this MFP is small enough to place almost anywhere.

*Height is 653 mm for the BP-20C25/20C20 models.



Direct Printing/Scanning with USB Drives

You can directly print from—or scan to—a USB drive, without using a PC.



Simulate installation with the AR app

Want to display a life-size image* of a Sharp MFP on your mobile device? Use the AR marker, which you can print out from Sharp's website. This makes it easy to imagine what the MFP will look like in your office or workplace. For details, visit <https://global.sharp/products/copier/downloads/armarkers/> or scan the QR Code on the right.

*The measurement of the on-screen MFP may not appear exact in some cases.



Stylish Design

The MFP's simple cubic form and two-tone colouring matches any business setting.



Wireless Connectivity*

The MFP can connect wirelessly with Wi-Fi-capable mobile devices.

*Requires optional MX-EB18. Availability of this option varies by country/region.

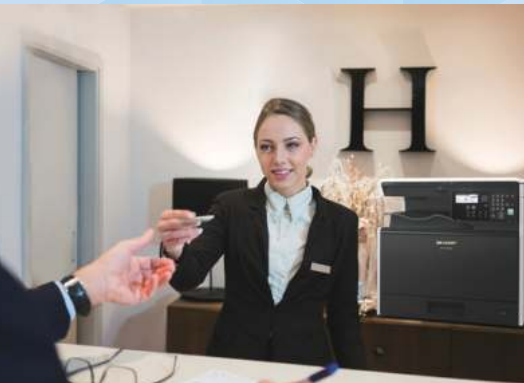

Link with Mobile Devices

The Sharpdesk Mobile* app lets you smoothly print from—or scan to—a mobile device.

*Availability varies by country/region. For details, see the Sharpdesk Mobile support website: https://global.sharp/products/copier/docu_solutions/mobile/sharpdesk_mobile/



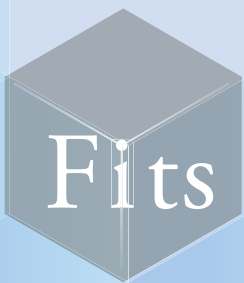

a range of work styles

- Want to work more efficiently
- Want to print on different paper types
- Want to reduce paper use

ID Card Copy

The MFP has a dedicated key that lets you easily copy both sides of a card onto a single page. Whether it's an ID card or a driver's license, you save time, effort, *and* paper.

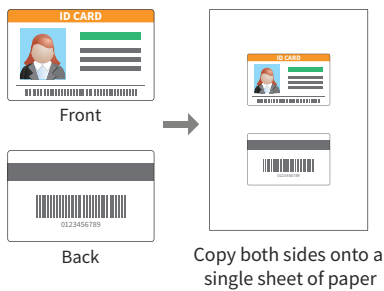

Versatile Paper Handling

The main unit paper tray can take paper sizes from A3 to A5, while the multi bypass tray can also handle A6 paper. The optional paper feed units handle paper up to 220 g/m² thick, while the multi bypass tray takes paper up to 256 g/m² thick*¹. In addition to plain paper, the MFP can handle a number of other paper types*², such as envelopes, removable adhesive paper, and glossy paper. Versatile paper handling like this gives you more scope for different printing applications.

*1: 256 g/m² thick paper cannot be fed via main unit paper tray.
 *2: Must be fed via multi bypass tray.

Envelopes

Perforated card stock

Rye	Sourdough
\$2.00	\$4.50
Baguette	Cinnamon roll
\$3.50	\$3.25
Focaccia	Hot cross bun
\$4.75	\$2.25
Whole wheat	Spinach & feta roll
\$4.25	\$3.75
Multi-grain	Kaiser roll
\$5.00	\$1.75

Price cards

Cardboard

Table tents

Note: Contact a Sharp customer representative for details.

Automatic Paper Setting Screen

When you feed paper into the multi bypass tray, a paper setting window pops up automatically on the LCD control panel. You don't need to manually call up the setting screen.

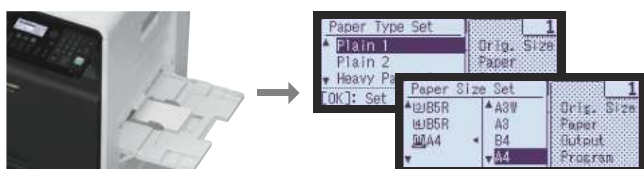

Multiple Scan Destinations

There are many ways to distribute scanned documents. They can be sent to an FTP server, to a network folder, or to a USB drive. Or they can be sent directly to a designated PC desktop* or as e-mail attachments.

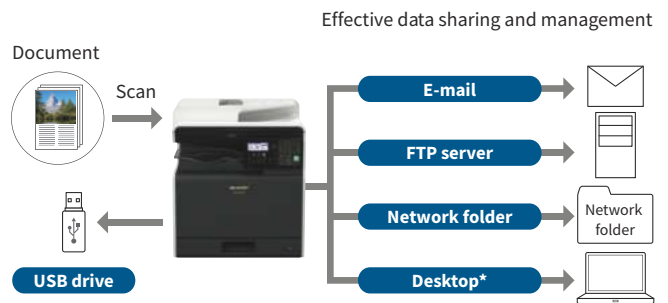

*Requires Network Scanner Tool Lite.

Automatic Document Feeding

An RSPF* (reversing single pass feeder) efficiently feeds in up to 100 sheets of either one- or two-sided originals. Because you can feed in a batch of multiple pages at once, it boosts copying and scanning efficiency.



*Not available on BP-10C20.

Poster Printing*

The MFP can enlarge an image (print data) by up to 16 times (4 x 4) and then divide it into separate sheets for printing. You can then stick the sheets together to make a giant poster.

*For Windows® OS only



The sheets have a margin so you can glue them together

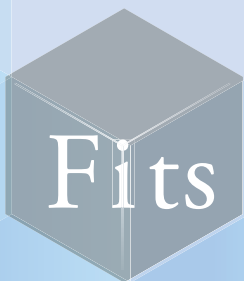

fits various business scenarios

- Want essential business functions
- Want to integrate printer and fax functions
- Want to check faxes while outside the office

Printing Two Pages on One Sheet

Duplex printing allows printing on both sides of a sheet of paper. The MFP can also print two pages of content on the same side of a sheet of paper. Using both of these functions at the same time lets you print four pages on one sheet. It's a great way to reduce paper use and cut paper costs.

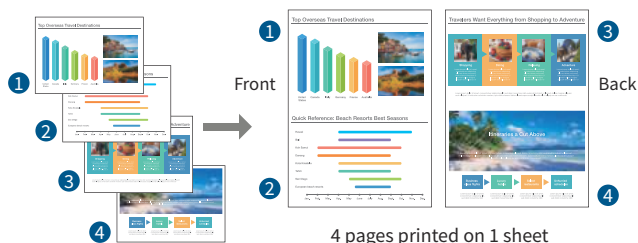

Auto Zoom Selection and Fit-to-Page Function

The MFP automatically reduces or enlarges the image to fit the selected paper size. You don't need to manually set the zoom ratio, so there's less chance of printing errors.

Rotation Sort*

Every other copy of a document is rotated 90 degrees when it's delivered to the output tray. This takes the hassle out of sorting copies and comes in handy when you need to print many copies of multi-page documents.

*Two paper trays must be loaded with the same-sized paper in a different orientation (landscape and portrait).

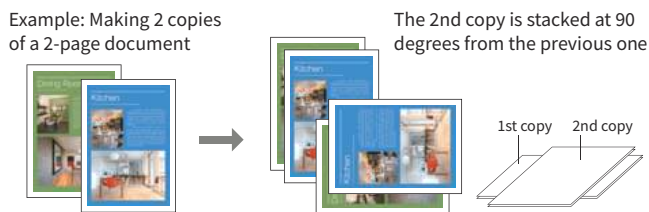

Network Scanner Tool Lite*

Document data scanned on the MFP can be sent to and stored on your PC via a network. With Network Scanner Tool Lite, you can easily store large-volume data (or many separate originals) in a specified folder on your PC.

*Download from the following website:
<https://global.sharp/products/copier/downloads/>

Print Hold and Confidential Print

The MFP's Print Hold function withholds output until you execute a print command from the control panel. For extra security, the Confidential Print function requires you to enter a PIN code at the MFP before printing can start.

Super G3 Fax*

The MFP can work as a Super G3 fax machine, employing JBIG data compression for fast transmission times. Sending files quickly helps to reduce transmission costs.

*Not available on BP-10C20. BP-20C25/20C20 requires optional BP-FX10.

PC-Fax Transmission*

You can directly send a document created on your PC to a recipient's fax machine via the MFP. This saves time, effort, *and* paper, because you don't need to print the document before faxing it.

Send a fax directly from a PC without printing to paper



*Not available on BP-10C20. BP-20C25/20C20 requires optional BP-FX10.

Inbound Routing*1

Inbound routing lets you forward received faxes to a PC desktop*2, FTP server, network folder, or e-mail address without printing to paper.

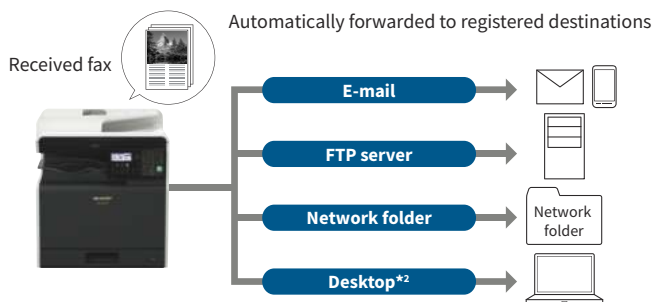

*1: Not available on BP-10C20. BP-20C25/20C20 requires optional BP-FX10.

*2: Requires Network Scanner Tool Lite.

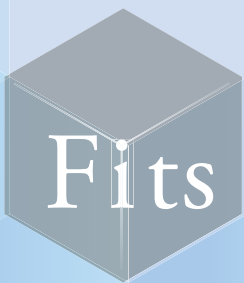

Fits your needs

- Want an MFP that can be used intuitively
- Want to protect confidential information
- Want to reduce power consumption

5-Line LCD with Backlight

The MFP’s control panel is designed to be easy to use. Along with function icons and large buttons, it features a 5-line LCD with backlight. The buttons are indented in the middle to make them easier to press.

Free-Tilting Control Panel

The control panel can be tilted freely at various angles. This gives you easy viewing and easy operation, no matter where the MFP is placed or who is using it.



Pop-up Command Screen

Insert a USB drive into the MFP and a command screen will automatically pop up on the LCD. Right away you can print files from the USB drive or scan documents directly to the USB drive.

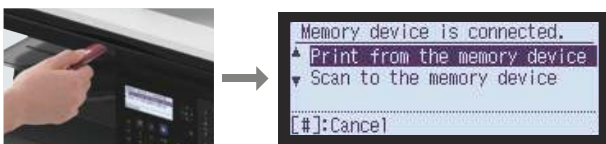

Eco Scan

The Eco Scan function saves energy by keeping the fusing system shut down whenever it’s not needed—for example, when you’re sending scans or faxes.

Auto Power Shut-off

To save electricity, an auto power shut-off function automatically puts the MFP into energy-saving mode after a period of inactivity.



Green LED status lamp Fax function keys Scanner program keys ID Card Copy key Red LED status lamp

LED Status Lamps

On the control panel are two LED lamps: one red, one green. These light up to notify you—even from a distance—that, for example, the machine is “now printing” or “out of paper.”

Job Programs and Scanner Program Keys

These features let you register frequently used functions and settings for easy, one-touch recall. This eliminates the need to make settings each time.

SSL and IPsec

SSL encryption gives you secure network communications for actions such as printing, e-mailing, or accessing an FTP server. Network security is further boosted by IPsec, which encrypts packets of data sent over the IP network.

IP/MAC Address Filtering

Only PCs, smartphones, and tablets whose IP address or MAC address is registered are allowed to access the MFP.

User Authentication

User authentication restricts access to the MFP by requiring a password. Up to 30 users can be registered this way.

Data Erasure

Retained data, including personal information, can be erased when it’s time to replace the MFP. This helps to protect your confidential information.

System Configuration

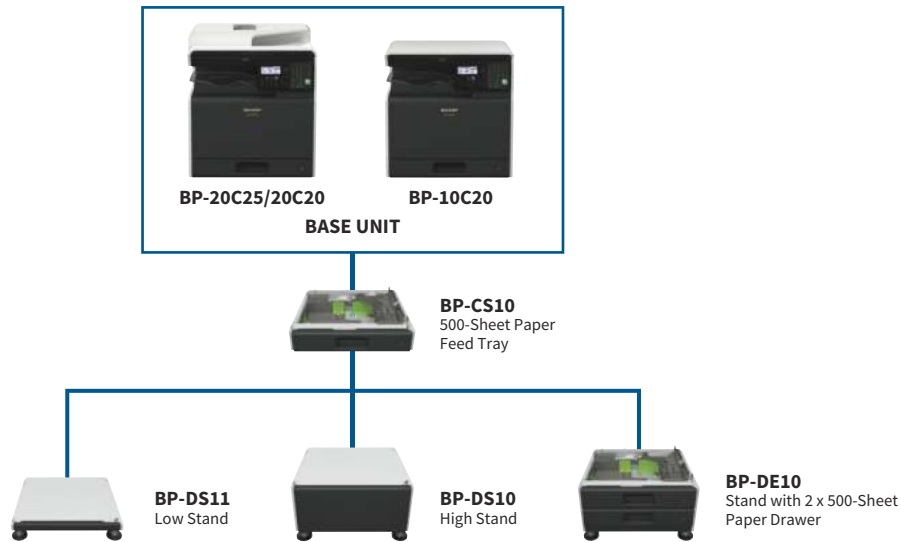

MX-PK11
PS3 Expansion Kit

MX-EB18
Wireless LAN Adaptor

Optional for BP-20C25/20C20

BP-FX10
Facsimile Expansion Kit

Note: If you install the MFP on a floor, Sharp recommends setting it up on a stand (either the BP-DS11, BP-DS10, or BP-DE10). This set-up also requires the BP-CS10 paper tray option.

Certain optional equipment may not be available in some areas.

Specifications for Optional Equipment

BP-CS10 500-Sheet Paper Feed Tray

Paper size	A3 (11" x 17") to A5 (5 1/2" x 8 1/2")*1
Paper capacity	500 sheets
Dimensions (W x D x H)	560 x 560 x 145 mm (22 1/16" x 22 1/16" x 5 23/32")
Weight (approx.)	6.7 kg (14.8 lbs)

BP-DE10 Stand with 2 x 500-Sheet Paper Drawer

Paper size	Upper and lower tray	A3 (11" x 17") to A5 (5 1/2" x 8 1/2")*1
Paper capacity	Upper and lower tray	500 sheets each
Dimensions (W x D x H)		560 x 585 x 329 mm (22 1/16" x 23 3/64" x 12 61/64")
Weight (approx.)		21 kg (46.3 lbs)

BP-DS11 Low Stand

Dimensions (W x D x H)*2	560 x 585 x 102 mm (22 1/16" x 23 3/64" x 4 1/32")
Weight (approx.)	4.6 kg (10.2 lbs)

BP-DS10 High Stand

Dimensions (W x D x H)*2	560 x 585 x 311 mm (22 1/16" x 23 3/64" x 12 1/4")
Weight (approx.)	11 kg (24.3 lbs)

Note: All specifications relating to paper capacity refer to 80 g/m² paper.

*1: Only short-edge feeding can be used with A5 (5 1/2" x 8 1/2") paper.

*2: Including adjusters and protuberances.

External Dimensions (Unit: mm)

Desktop

Front

Base Unit (standard)

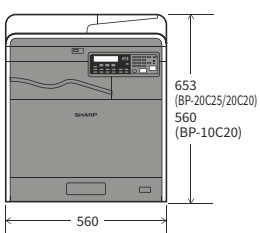

Base Unit + Paper Feed Tray

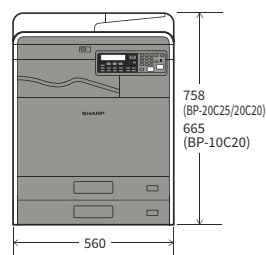

Top

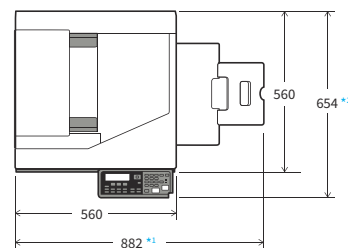

Console

Front

Base Unit + Paper Feed Tray + Low Stand

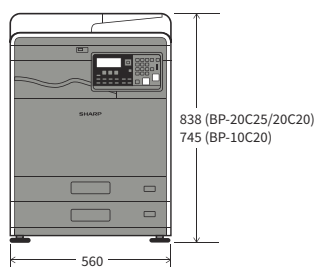

Base Unit + Paper Feed Tray + High Stand

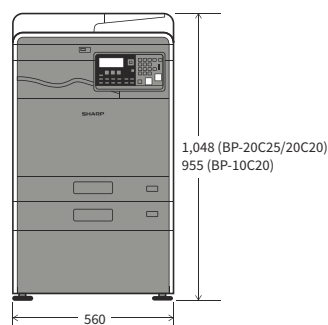

Base Unit + Paper Feed Tray + Stand with 2 x Paper Drawer

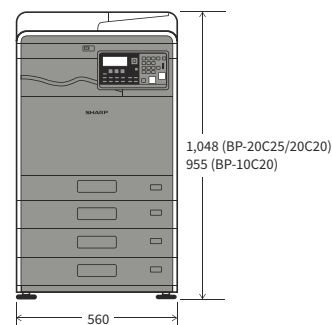

Top

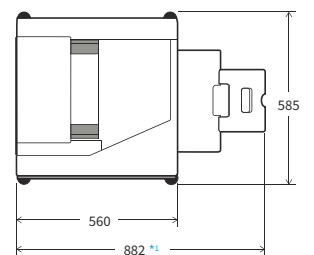

*1 When multi bypass tray is extended. *2 When the control panel is tilted at the flattest horizontal angle.

SPECIFICATIONS

General

Type	Desktop
Engine speed	A4 (8 1/2" x 11")*1: Max. 25/20/20 ppm A3 (11" x 17"): Max. 14/12/12 ppm
Control panel display	5-line LCD
Paper size	Max. A3W (12" x 18"), min. A6 (5 1/2" x 8 1/2")*2
Paper capacity (80 g/m ²)	Standard: 350 sheets (250-sheet tray and 100-sheet multi bypass tray) Maximum: 1,850 sheets (350 sheets & optional 3 x 500-sheet tray)
Paper weight	Tray 1: 60 g/m ² to 105 g/m ² (16 lbs bond to 28 lbs bond) Trays 2-4 (BP-CS10/DE10): 60 g/m ² to 220 g/m ² (16 lbs bond to 80 lbs cover) Multi bypass tray: 55 g/m ² to 256 g/m ² (13 lbs bond to 140 lbs index)
Warm-up time*3	29 sec.
Memory	2 GB (copy/print shared)
Power requirements	Rated local AC voltage ±10%, 50/60 Hz
Power consumption	Max. 1.44 kW (110 V to 120 V), max. 1.84 kW (220 V to 240 V)
Dimensions (W x D x H)	[BP-20C25/20C20] 560 x 560 x 653 mm (22 1/16" x 22 1/16" x 25 23/32") [BP-10C20] 560 x 560 x 560 mm (22 1/16" x 22 1/16" x 22 1/16")
Weight (approx.)	[BP-20C25/20C20] 52 kg (112.5 lbs) [BP-10C20] 47 kg (103.7 lbs)

Copier

Original paper size	Max. A3 (11" x 17")
First copy time*4	Colour: 11.5 sec. B/W: 8.0 sec.
Continuous copy	Max. 999 copies
Resolution	Scan: 600 x 600 dpi, 600 x 400 dpi Print: 600 x 600 dpi
Gradation	Equivalent to 256 levels
Zoom range	25% to 400% (25% to 200% using RSPF) in 1% increments
Pre-set copy ratios	Metric: 10 ratios (5R/5E), inch: 8 ratios (4R/4E)

Scanner

Scan method	Push scan (via control panel) Pull scan (TWAIN-compliant application)
Scan speed*5	[Colour & B/W] Max. 37 originals/min.
Resolution	Push scan: 100, 150, 200, 300, 400, 600 dpi Pull scan: 75, 100, 150, 200, 300, 400, 600 dpi 50 dpi to 9,600 dpi via user setting*6
File formats	TIFF, PDF, JPEG*7
Scan destinations	Scan to e-mail/desktop*/FTP server/network folder (SMB)/USB drive

Printer

Resolution	600 x 600 dpi
Interface	USB 2.0 (host, high-speed), 10Base-T/100Base-TX/1000Base-T, wireless LAN (IEEE 802.11 b/g/n)*9
Supported OS*10	Windows Server® 2008, Windows Server® 2008 R2, Windows Server® 2012, Windows Server® 2012 R2, Windows Server® 2016, Windows Server® 2019, Windows® 7, Windows® 8.1, Windows® 10, Mac OS 10.6, 10.7, 10.8, 10.9, 10.10, 10.11, 10.12, 10.13, 10.14, 10.15
Network protocols	TCP/IP
Printing protocols	LPR, Raw TCP (port 9100), FTP for downloading print files, IPP, WSD
PDL	Standard: PCL 6 emulation Option: PostScript® 3™ emulation
Available fonts	80 fonts for PCL, 136 fonts for PostScript 3 emulation

Facsimile (requires optional BP-FX10)*11

Compression method	MH/MR/MMR/JBIG
Communication protocol	Super G3/G3
Transmission time	Less than 3 seconds*12
Modem speed	33,600 bps to 2,400 bps with automatic fallback
Transmission resolution	From Standard (203.2 x 97.8 dpi) to Ultra Fine (406.4 x 391 dpi)
Recording size	A3 to A5 (11" x 17" to 5 1/2" x 8 1/2")
Memory	64 MB (built-in)
Greyscale levels	Equivalent to 256 levels

- Design and specifications are subject to change without prior notice.
- QR Code is a registered trademark of DENSO WAVE INCORPORATED in Japan and other countries. AReader and the AReader logo are registered trademarks of Tokyo Shoseki Co., Ltd. IOS is a trademark or registered trademark of Cisco Systems, Inc. in the US and other countries and is used under license by Apple Inc. Android is a trademark of Google LLC. Windows and Windows Server are either registered trademarks or trademarks of Microsoft Corporation in the US and/or other countries. Mac is a trademark of Apple Inc., registered in the US and other countries. PCL is a registered trademark of Hewlett-Packard Company. PostScript 3 is either a registered trademark or trademark of Adobe in the US and/or other countries. All other brand names and product names may be trademarks or registered trademarks of their respective owners.

- *1: Long-edge feeding.
- *2: Only short-edge feeding can be used with A6 (5 1/2" x 8 1/2") paper.
- *3: In a standard measurement environment. May vary depending on operating conditions and environment.
- *4: Long-edge feeding of A4 (8 1/2" x 11") sheets from 1st paper tray, using document glass, MFP in fully ready condition. May vary depending on operating conditions and environment.
- *5: Scan speed will vary depending on the type of document, the scan settings, operating conditions, and environment. Based on Sharp's A4 standard chart, using document feeder, long-edge feeding, one-sided scanning, and factory default settings.
- *6: Resolution will vary depending on the size of the scanned area.
- *7: Colour/greyscale only.
- *8: Requires Network Scanner Tool Lite.
- *9: Requires optional MX-EB18. Availability of this option varies by country/region.
- *10: Requires optional MX-PK11 for Mac OS.
- *11: Not available for the BP-10C20.
- *12: Based on Sharp's standard chart with approx. 700 characters (A4 or 8 1/2" x 11" short-edge feeding) at standard resolution in Super G3 mode, 33,600 bps, JBIG compression.

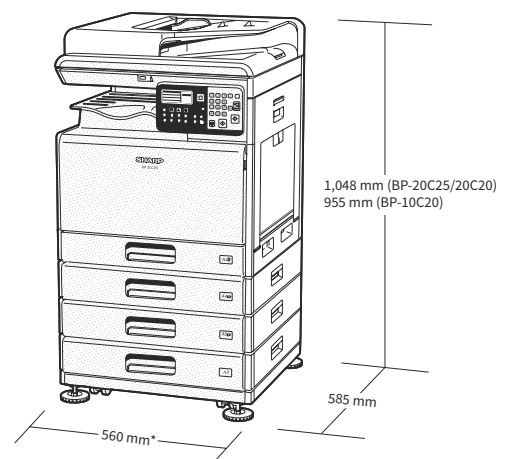

* 882 mm when multi bypass tray is extended.

BP-20C25 shown with optional equipment.

Distributed by:

SHARP